

BRLP02-210W/LED

Due to technical reasons about the light's functionality, it is not suitable to demount/change the light source.

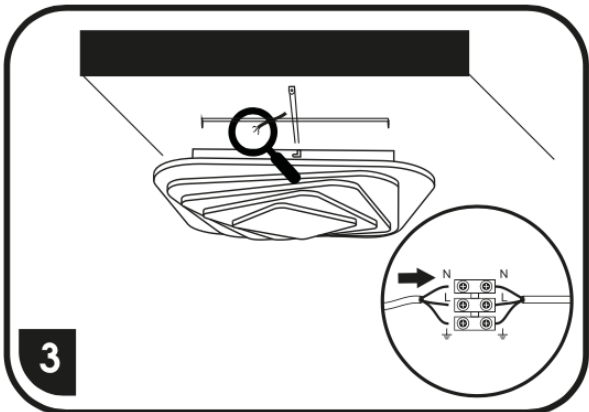

THE LIGHTS ARE ALREADY PAIRED WITH THE REMOTE CONTROL BY THE MANUFACTURER

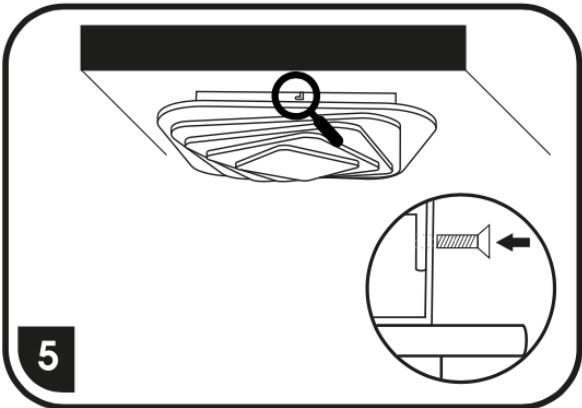
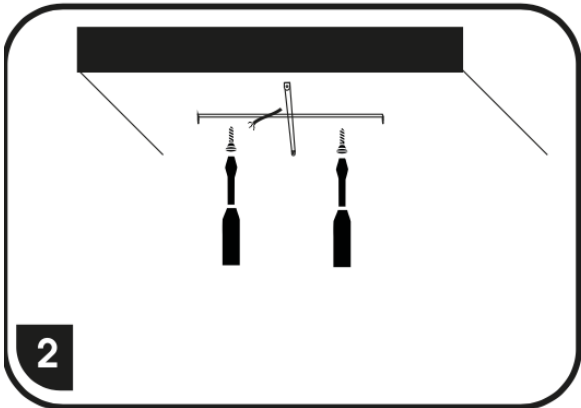
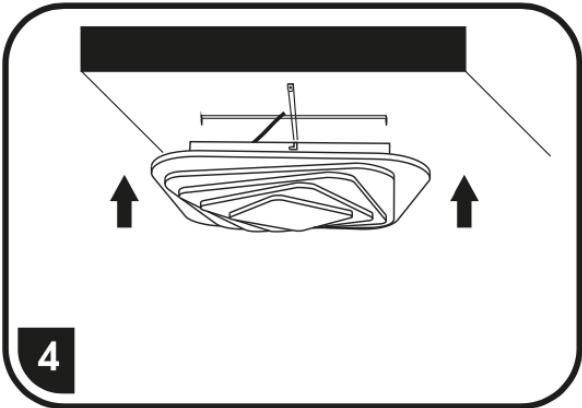
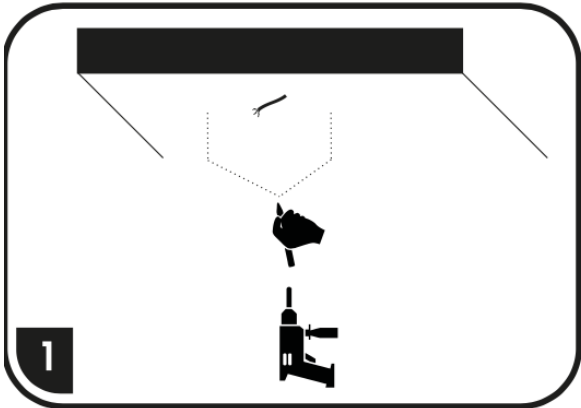
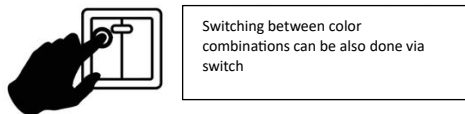
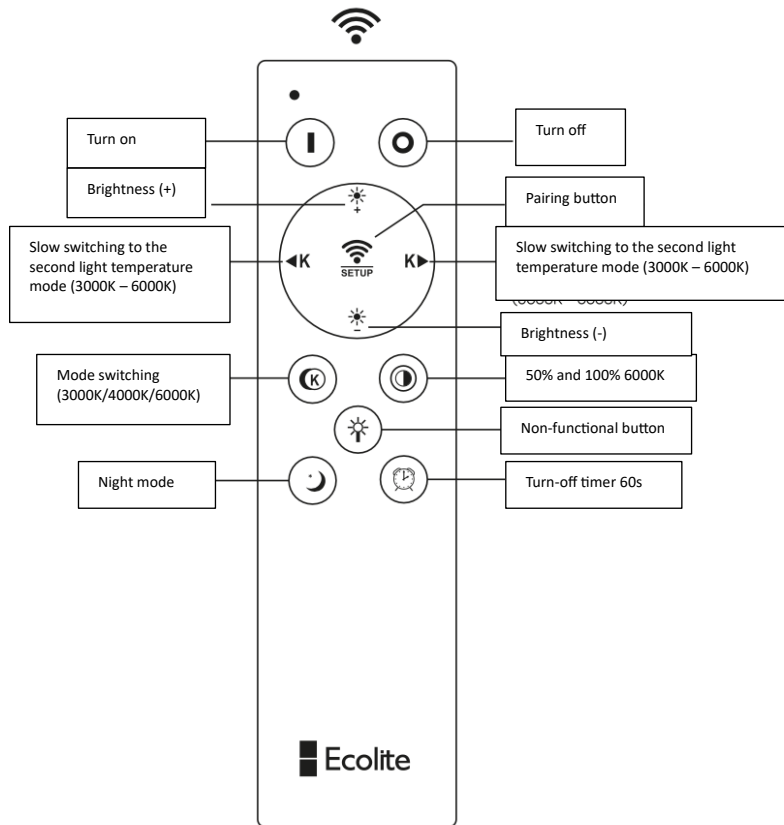

The lights are already paired with the remote control by the manufacturer. If the remote control doesn't communicate with the light, pair them.

Light and remote control pairing

-the pairing is done by first turning on the light via a wall switch and within 3 seconds, you have to press the pairing button  (the light will flicker once and that means that the pairing has been done).

Light and remote control unpairing

-the unpairing is done by first pressing the ON button  and holding it until the light turns on and within 3 seconds, the light will flicker once which means that the unpairing has been done.

